

Kavrama çapı 17.8 Ø

Konik 1:10

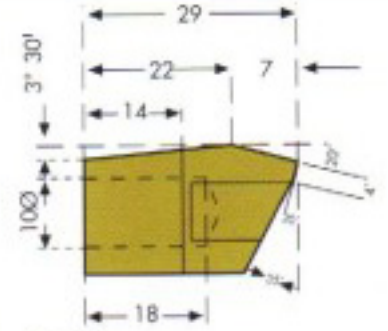

Elektrot No.

» L « mm

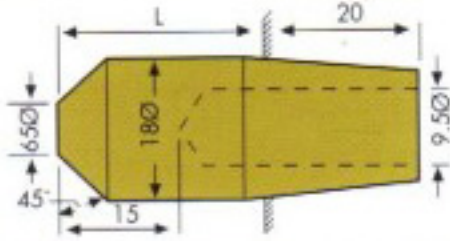

AR / 1120

25

AR / 1121

40

AR / 1122

55

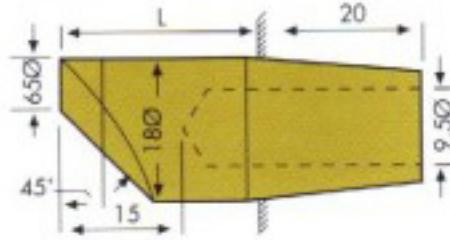

AR / 1123

25

AR / 1124

40

AR / 1125

55

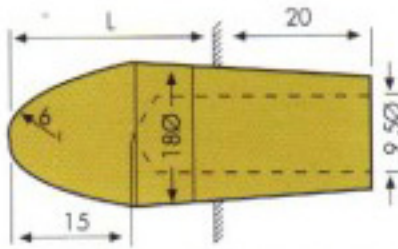

AR / 1126

25

AR / 1127

40

AR / 1128

55

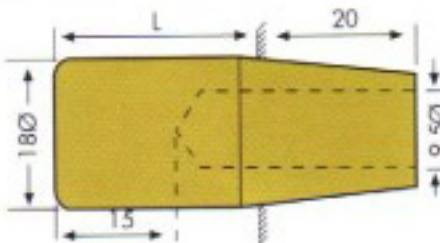

AR / 1129

25

AR / 1130

40

AR / 1131

55

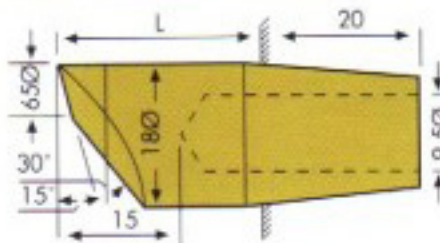

AR / 1132

25

AR / 1133

40

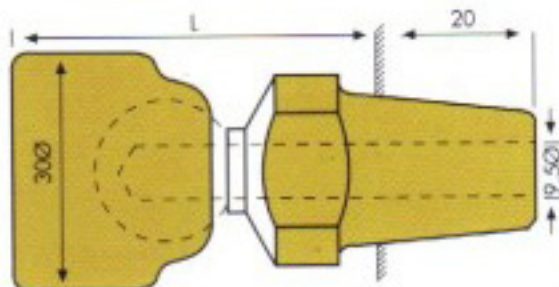

AR / 1140

45